

TUBES RAYONNANTS SOMBRES

	Type	Modèle	Particularités	Page
Gamme actuelle	SOLARTUBE HAUTE PERFORMANCE	TU.E17 - TU.E27 TU.E37 - HP	Réflecteur isolé	10
	SOLARTUBE EVOLUTION TU.E - TU.E-C - TLE	TU.E12 - TU.E17 - TU.E23 - TU.E36 - TU.E23C - TU.E36C - TLE.E23 - TLE.E36 - TLE.E45	Cadre porteur	10
	HARMOTUBE (SOLARTUBE EVOLUTION CARROSSÉ)	HU12 - HU17 - HU23 - HU36 - HL23 - HL36 - HL45	Cadre porteur	10
	TUP	TUP50	Brûleur à flamme poussée	18
Anciennes Gammes	TU - TU.C - TL	TU 17 - 23 - 36 - TUC 23 - 36 - TL 17 - 23 - 36 - 45	Brûleur avec caisson et extracteur nu	23
	STU II - STL	23 kW	Deux caissons aluminés	30
	STUI	23 kW	Orange ou rouge avec filtre à air	33

BANDES RADIANTES CENTRALISÉES

	Type	Modèle	Particularités	Page
Gamme actuelle	Rayline	RSB 65 - 75 - 110 - 130 - 165 - 200 - 220	Haute performance rayonnement	37
Ancienne Gamme	TUBONE	35 - 50 - 80 - 100 - 150 - 200 - 300	Caisson Brûleur Inox	41

PANNEAUX RADIANTS LUMINEUX

	Type	Modèle	Particularités	Page
Gamme actuelle	SR II	21 - 31 - 41 - 42 - 62 - 82 - 61 - 81	Absence de caisson sur électrovanne	46
Anciennes Gammes	SR I	21 - 31 - 41 - 42 - 62 - 82	Caisson Orange	51
	SR I Bis		Caisson aluminé	
	SOLARPLUS	26 - 36 - 48	Appareil Orange dans sa totalité	Fermé
	MHKY & AKHY	30 - 60 - 88 - 120	Orange ou rouge avec filtre à air	Fermé

RÉSEAUX RADIANTS MULTI-BRÔLEURS

	Type	Modèle	Particularités	Page
Gamme actuelle	EUROLINE - HARMOLINE - BRT	20 - 30 - 40	Aluminé avec filtre interne	54
Anciennes Gammes	RMTS	18 - 24 - 30	Rouge avec filtre interne	62
	RMT	15 - 18 - 24	Gris avec filtre à air cylindrique	66
	NRV & CRV	15 - 18 - 24	Orange ou rouge avec filtre à air cylindrique	Fermé

Type SOLARTUBE EVOLUTION TU.HP - TU.E - TU.E-C - TL.E

SOLARTUBE HAUTE PERFORMANCE DESIGN

Composants N°	Dénomination	Page
A	Caisson brûleur / Burner box	11
B	Support / Support	*
C	Réflecteur isolant / Reflective insulation	*
D	Tube émetteur / Emitter	*
E	Grille pare balles / Grid (ball-impact guard)	16

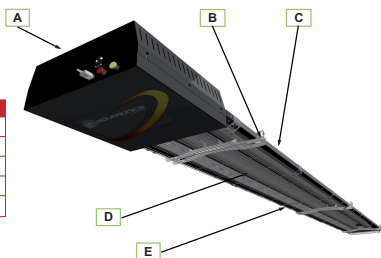

SOLARTUBES HAUTE PERFORMANCE

Composants N°	Dénomination	Page
A	Brûleur / Burner	11
B	Extracteur / Smoke extractor	12
C	Cadre porteur / Ladder chassis	*
D	Support / Support	*
E	Réflecteur / Reflector	*
F	Tube émetteur / Emitter	16

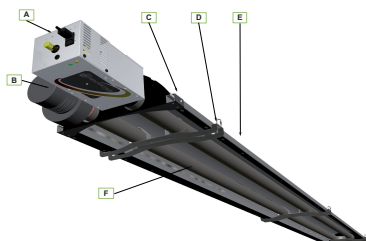

SOLARTUBES EVOLUTION TU.E - TU.E-C

Composants N°	Dénomination	Page
A	Brûleur / Burner	11
B	Extracteur / Smoke extractor	12
C	Cadre porteur / Ladder chassis	*
D	Support / Support	*
E	Réflecteur / Reflector	*
F	Tube émetteur / Emitter	16

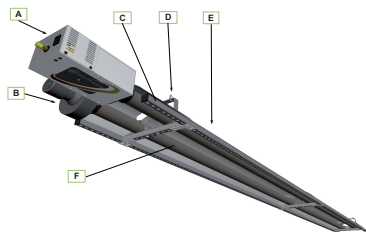

* Sur consultation uniquement

Brûleurs SOLARTUBE TU.HP - TU.E - TU.E-C - TL.E

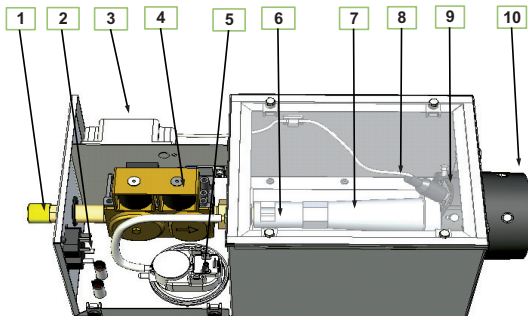

Composants N°	Dénomination	Page
1	Ligne gaz /Gas inlet tube	*
2	Connecteur / Double power socket	14
3	Boîtier flamme /Gas burner control	14
4	Electrovanne gaz / Gas valve	14
5	Pressostat / Pressure switch	12
6	Injecteur / Injector	*
7	Brûleur / Burner	*
8	Câble allumage et ionisation / High voltage cable and ionisation	14
9	Electrode allumage et ionisation / Spark and ionisation electrodes	14
10	Bride de raccordement / Mounting flange	*

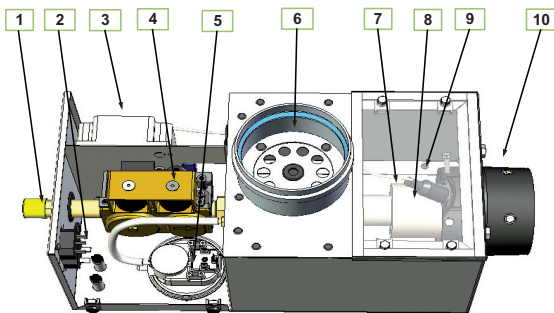











































Composants N°	Dénomination	Page
1	Ligne gaz /Gas inlet tube	*
2	Connecteur / Double power socket	14
3	Boîtier flamme /Gas burner control	14
4	Electrovanne gaz / Gas valve	14
5	Pressostat / Pressure switch	12
6	Prise air comburant / Combustion air suction	*
7	Brûleur / Burner	*
8	Câble allumage et ionisation / Hight voltage cable and ionisation	14
9	Electrode allumage et ionisation / Spark and ionisation electrodes	14
10	Bride de raccordement / Mounting flange	*

* Sur consultation uniquement

Type SOLARTUBE EVOLUTION TU.HP - TU.E - TU.E-C - TLE

BRULEURS - EXTRACTEURS - PRESSOSTATS -

Repère	Référence	Désignation	Port /	Prix € HT
B	8330009	Kit extracteur complet / Extractor kit		**
B	8330008	Kit extracteur complet / Extractor kit		**
B	8330003	Kit extracteur complet / Extractor kit		**
B	8330005	Kit extracteur complet / Extractor kit		**
B	8330016	Kit extracteur complet / Extractor kit		**
B	8330017	Kit extracteur complet / Extractor kit		**
B	8320014	Extracteur nu (sans accessoires) / Extractor		**
B	8320015	Extracteur nu (sans accessoires) / Extractor		**
B	8320013	Extracteur nu (sans accessoires) / Extractor		**
*	8350023	Câble haute température / High temperature cable 10m		**
*	8350026	Câble haute température / High temperature cable 12,7m		**
*	8350027	Câble haute température / High temperature cable 14,5		**
5	9422012	Pressostat brûleur / Pressure switch		**
5	9422014	Pressostat brûleur / Pressure switch		**
5	9422017	Pressostat brûleur / Pressure switch		**
5	9422018	Pressostat brûleur / Pressure switch		**
A	8390000	Caisson brûleur / Burner housing G20		**
A	8390001	Caisson brûleur / Burner housing G20		**
A	8390007	Caisson brûleur / Burner housing G20		**
A	8390008	Caisson brûleur / Burner housing G20		**
A	8390004	Caisson brûleur / Burner housing G20		**
A	8390005	Caisson brûleur / Burner housing G20		**
A	8390009	Caisson brûleur / Burner housing G20		**
A	8390010	Caisson brûleur / Burner housing G20		**
A	8390011	Caisson brûleur / Burner housing G20		**
A	8390020	Caisson brûleur / Burner housing G25		**
A	8390021	Caisson brûleur / Burner housing G25		**
A	8390022	Caisson brûleur / Burner housing G25		**
A	8390023	Caisson brûleur / Burner housing G25		**
A	8390024	Caisson brûleur / Burner housing G25		**
A	8390025	Caisson brûleur / Burner housing G25		**
A	8390026	Caisson brûleur / Burner housing G25		**
A	8390027	Caisson brûleur / Burner housing G25		**
A	8390028	Caisson brûleur / Burner housing G25		**
A	8390030	Caisson brûleur / Burner housing G31		**
A	8390031	Caisson brûleur / Burner housing G31		**
A	8390032	Caisson brûleur / Burner housing G31		**
A	8390033	Caisson brûleur / Burner housing G31		**
A	8390034	Caisson brûleur / Burner housing G31		**
A	8390035	Caisson brûleur / Burner housing G31		**
A	8390036	Caisson brûleur / Burner housing G31		**
A	8390037	Caisson brûleur / Burner housing G31		**
A	8390038	Caisson brûleur / Burner housing G31		**

Petit colis 24 h chrono / 

Type SOLARTUBE EVOLUTION TU.HP - TU.E - TU.E-C - TLE

CABLES Hautes températures

Appareils non étanches							Appareils étanches			
TUE HU12	TU/TUE /HU17	TU/TUE /HU 23	TU/TUE /HU36	TL/TLE /HL23	TL/TLE /HL36	TL/TLE /HL45	TUE 23C	TUE36C	TU 17HP	TU 27HP
X	X	X		X			X			
			X		X			X		
						X			X	
										X
X	X	X		X			X			
			X		X			X		
						X				
				X						
					X					
						X				
X	X		X	X	X					
		X				X	X	X	X	X
X										
	X									
		X		X						
			X		X					
						X				
							X			
								X		
									X	
										X
X										
	X									
		X		X						
			X		X					
						X				
							X			
								X		
									X	
										X

Rayonnement

* Uniquement tube linéaire

Petit colis 24 h chrono /



Type SOLARTUBE EVOLUTION TU.E.HP - TU.E - TU.E-C - TLE



Boîtier contrôle de flamme / Gas burner control
RV 0512 BRT - TU - TUE - STU



Code : 9424134 Prix professionnel : **



Boîtier contrôle de flamme / Gas burner control
Spécifique TU HP 17-27-37



Code : 9424133 Prix professionnel : **



Electrovanne gaz / Gas valve
SIT 830 1/2 TU - TUE



Code : 9421001 Prix professionnel : **



Electrode allumage et ionisation / Spark and ionisation
electrodes
TU/TL



Code : 9412007 Prix professionnel : **



Câble haute tension / High voltage cable
TU



Code : 9412008 Prix professionnel : **



Câblage TUTL équipé électrovanne gaz SIT / Wiring
equipped for gas valve



Code : 8350011 Prix professionnel : **



Brûleur (tube) / Fitted burner
STU2/TU équipé



Code : 7320212 Prix professionnel : **



Socle de prise double / Double power socket
TU



Code : 9462037 Prix professionnel : **

NOTES

Type HARMOTUBE - Habillage

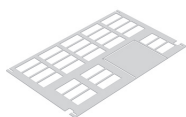

Plaque caisson coude / Harmotube cover short side
TUE/TLE



Code : 0061401 Prix professionnel : **

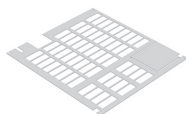

Plaque caisson brûleur / Harmotube cover long side
TUE/TLE



Code : 0061406 Prix professionnel : **



Liaison caisson / Harmotube link support
TUE/TLE



Code : 0061415 Prix professionnel : **



Plaque d' accrochage / Harmotube hanging support
TUE/TLE



Code : 0061416 Prix professionnel : **

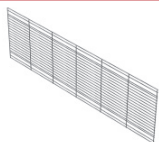

Grille Lg 1.620 m / Harmotube grid length 1.62



Code : 7301020 Prix professionnel : **

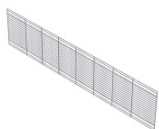

Grille Lg 2.250m / Harmotube grid length 2.25



Code : 7301021 Prix professionnel : **

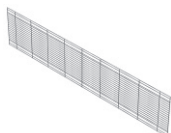

Grille Lg 2.430m / Harmotube grid length 2.43



Code : 7301022 Prix professionnel : **

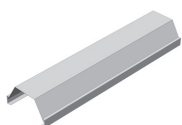

Déflecteur Lg 2000 / Harmotube reflector housing
length 2.0



Code : 7320260 Prix professionnel : **



Type HARMOTUBE - Habillage



Démontable Réflecteur Lg 1800 / Reflector



Code : 7320261 Prix professionnel : **

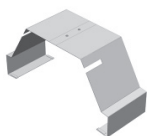

Pièce de recouvrement ouverte Lg 200 / Cover sheet (open)



Code : 7320262 Prix professionnel : **

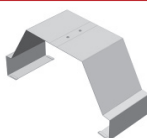

Pièce de recouvrement Lg 200 / Cover sheet



Code : 7320263 Prix professionnel : **

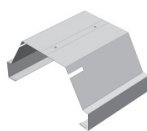

Pièce de recouvrement ouverte Lg 380 / Cover sheet (open)



Code : 7320265 Prix professionnel : **

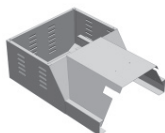

Caisson court HARMOTUBE / Harmotube housing short side



Code : 8320110 Prix professionnel : **

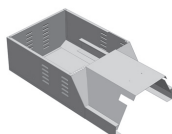

Caisson long HARMOTUBE / Harmotube housing long side



Code : 8320111 Prix professionnel : **



**: Voir fichier Excel

Petit colis 24 h chrono /



Type TUP

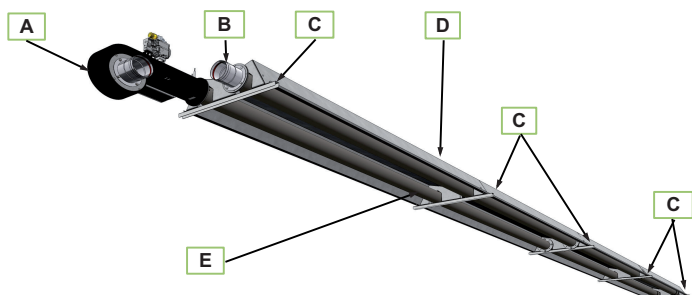

Composants N°	Dénomination	Page
A	Brûleur / Burner	*
B	Connecteur de fumées./ Smoke connector	21
C	Support / Support	*
D	Réflecteur/ Reflector	*
E	Tube émetteur / Emitter	*

* Sur consultation uniquement



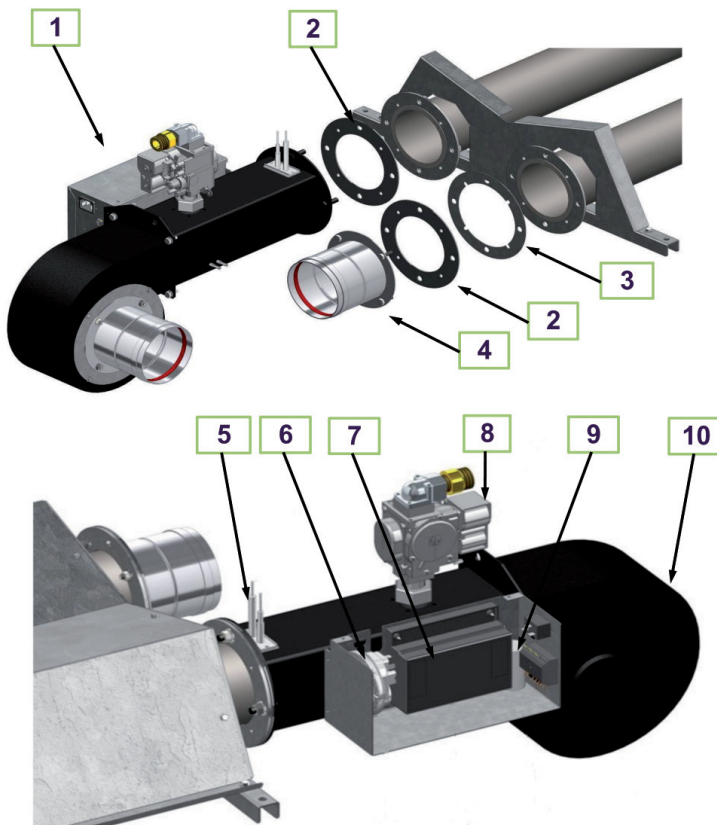













Type TUP

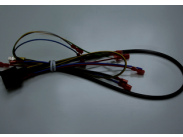

Composants N°	Dénomination	Page
1	Brûleur / Burner	*
2	Joint / Gasket	21
3	Entretoise	*
4	Connecteur de fumées / smoke connector	21
5	Electrode allumage et ionisation / Spark and ionisation electrodes	20
6	Pressostat / Pressure switch	20
7	Boîtier flamme / Gas burner control	20
8	Electrovanne gaz / Gas valve	20
9	Condensateur / Capacitor motor	20
10	Ventilateur brûleur / Fan burner	20

* Sur consultation uniquement

Type TUP

	Boîtier contrôle de flamme / Gas burner control "RV" TUP50	
Code : 9424031	Prix professionnel : **	
	Electrovanne gaz / Gas valve SIT 840 SIGMA 1/2" TUP50	
Code : 9421380	Prix professionnel : **	
	Platine électrodes plus câbles / Spark + detection electrodes TUP50	
Code : 9412425	Prix professionnel : **	
	Ventilateur nu / Fan TUP50	
Code : 8320205	Prix professionnel : **	
	Condensateur moteur 6 µF pour ventilateur / Motor capacitor for fan TUP50	
Code : 0074189	Prix professionnel : **	
	Câblage / Wiring TUP50	
Code : 8360050	Prix professionnel : **	
	Câble d'alimentation / Cable with plug TUP50	
Code : 8350028	Prix professionnel : **	
	Pressostat / Pressure switch TUP50 - TU 23 - 36 Etanche - TU.EHP 17-27-37	
Code : 9422018	Prix professionnel : **	

Type TUP



Tube silicone / Silicone tube
Dint4 D-ext6 TUP 50 (2 tubes)



Code : 9445241 **Prix professionnel : ****



Joint graphite diametre 160 mm



Code : 8360052 **Prix professionnel : ****

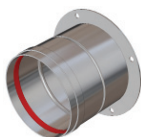

Connecteur bride de sortie



Code : 8360034 **Prix professionnel : ****

** : Voir fichier Excel

Petit colis 24 h chrono / 

NOTES

Ancienne gamme TU - TU-C - TL

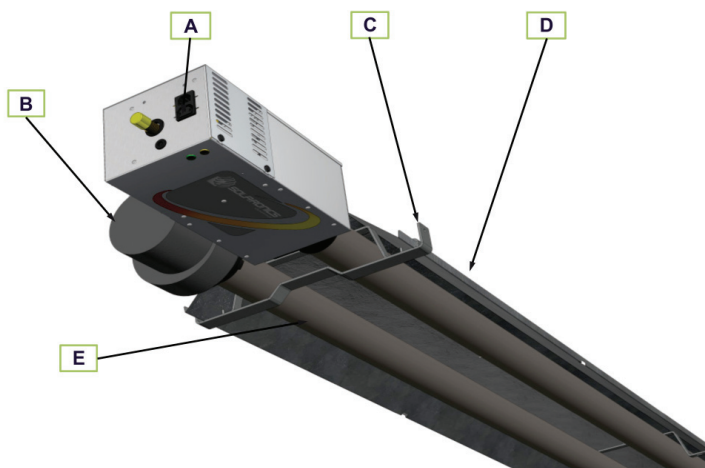





















































































Composants N°	Dénomination	Page
A	Caisson brûleur / Burner box	24
B	Extracteur / Smoke extractor	24
C	Support / Support	27
D	Réflecteur / Reflector	27
E	Tube émetteur / Emitter	*

* Sur consultation uniquement

Type SOLARTUBE EVOLUTION TU - TU-C - TL - HP

BRULEURS - EXTRACTEURS - PRESSOSTATS -

Repère	Référence	Désignation	Port /	Prix € HT
B	8330009	Kit extracteur complet / Extractor kit	 	**
B	8330008	Kit extracteur complet / Extractor kit	 	**
B	8330003	Kit extracteur complet / Extractor kit	 	**
B	8330005	Kit extracteur complet / Extractor kit	 	**
B	8330016	Kit extracteur complet / Extractor kit	 	**
B	8330017	Kit extracteur complet / Extractor kit	 	**
B	8320014	Extracteur nu (sans accessoires) / Extractor	 	**
B	8320015	Extracteur nu (sans accessoires) / Extractor	 	**
B	8320013	Extracteur nu (sans accessoires) / Extractor	 	**
*	8350023	Câble haute température / High temperature cable 10m	 	**
*	8350026	Câble haute température / High temperature cable 12,7m	 	**
*	8350027	Câble haute température / High temperature cable 14,5	 	**
5	9422012	Pressostat brûleur / Pressure switch	 	**
5	9422014	Pressostat brûleur / Pressure switch	 	**
5	9422017	Pressostat brûleur / Pressure switch	 	**
5	9422018	Pressostat brûleur / Pressure switch	 	**
A	8390000	Caisson brûleur / Burner housing G20	 	**
A	8390001	Caisson brûleur / Burner housing G20	 	**
A	8390007	Caisson brûleur / Burner housing G20	 	**
A	8390008	Caisson brûleur / Burner housing G20	 	**
A	8390004	Caisson brûleur / Burner housing G20	 	**
A	8390005	Caisson brûleur / Burner housing G20	 	**
A	8390009	Caisson brûleur / Burner housing G20	 	**
A	8390010	Caisson brûleur / Burner housing G20	 	**
A	8390011	Caisson brûleur / Burner housing G20	 	**
A	8390020	Caisson brûleur / Burner housing G25	 	**
A	8390021	Caisson brûleur / Burner housing G25	 	**
A	8390022	Caisson brûleur / Burner housing G25	 	**
A	8390023	Caisson brûleur / Burner housing G25	 	**
A	8390024	Caisson brûleur / Burner housing G25	 	**
A	8390025	Caisson brûleur / Burner housing G25	 	**
A	8390026	Caisson brûleur / Burner housing G25	 	**
A	8390027	Caisson brûleur / Burner housing G25	 	**
A	8390028	Caisson brûleur / Burner housing G25	 	**
A	8390030	Caisson brûleur / Burner housing G31	 	**
A	8390031	Caisson brûleur / Burner housing G31	 	**
A	8390032	Caisson brûleur / Burner housing G31	 	**
A	8390033	Caisson brûleur / Burner housing G31	 	**
A	8390034	Caisson brûleur / Burner housing G31	 	**
A	8390035	Caisson brûleur / Burner housing G31	 	**
A	8390036	Caisson brûleur / Burner housing G31	 	**
A	8390037	Caisson brûleur / Burner housing G31	 	**
A	8390038	Caisson brûleur / Burner housing G31		**

Type SOLARTUBE EVOLUTION TU - TU-C - TL - HP

CABLES Hautes températures

Appareils non étanches							Appareils étanches			
TUE HU12	TU / TUE / HU17	TU / TUE / HU 23	TU / TUE / HU36	TL / TLE /HL23	TL / TLE / HL36	TL / TLE / HL45	TUE 23C	TUE36C	TU 17HP	TU 27HP
X	X	X		X			X			
			X	X	X			X		
						X			X	
										X
X	X	X		X			X			
			X		X			X		
						X				
				X						
					X					
X	X		X	X	X					
		X				X				
							X	X	X	X
X										
	X									
		X		X						
			X		X					
						X				
							X			
								X		
									X	
X										
	X									
		X		X						
			X		X					
						X				
							X			
								X		
									X	
										X















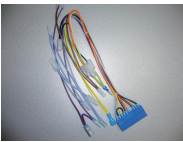

Rayonnement

* Uniquement tube linéaire

















Petit colis 24 h chrono /

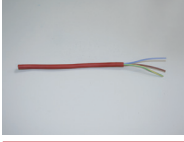

Type SOLARTUBE EVOLUTION TU - TU-C - TL

	Boîtier contrôle de flamme / Gas burner control RV 0512 BRT - TU - TUE - STU	
Code : 9424134	Prix professionnel : **	
	Electrovanne gaz / Gas valve SIT 830 1/2 TU - TUE	
Code : 9421001	Prix professionnel : **	
	Electrode allumage et ionisation / Spark and ionisation electrodes TU/TL	
Code : 9412007	Prix professionnel : **	
	Câble haute tension / High voltage cable TU	
Code : 9412008	Prix professionnel : **	
	Câblage TULT équipé électrovanne gaz SIT / Wiring equipped for gas valve	
Code : 8350011	Prix professionnel : **	
	Brûleur (tube) / Fitted burner STU2/TU équipé	
Code : 7320212	Prix professionnel : **	
	Tube silicone / Silicone tube Ø-int5 Ø-ext8 TU	
Code : 9445240	Prix professionnel : **	
	Socle de prise double / Double power socket TU	
Code : 9462037	Prix professionnel : **	

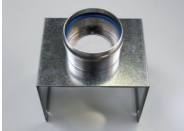
Type SOLARTUBE EVOLUTION TU - TU-C - TL

	Prise mâle pour extracteur / Socket for extractor TU	
Code : 0074499	Prix professionnel : **	
	Prise alimentation / Power plug TU	
Code : 0074502	Prix professionnel : **	
	Voyant Néon Orange / Orange neon indicator 250V (AMBRE)	
Code : 0074540	Prix professionnel : **	
	Voyant fluorescent Vert / Green fluorescent indicator 250V	
Code : 0074541	Prix professionnel : **	
	Câble haute température 3X0.75 LICC "ROUGE" au mètre High temperature cable RED per meter	
Code : 0074297	Prix professionnel : **	
	Ecran de rayonnement sous tube / Screen	
Code : 8130811	Prix professionnel : **	
	Support écran de rayonnement sous tube / Screen fixation	
Code : 8130812	Prix professionnel : **	
	Reprise d'air comburant extérieur / Combustion air suction kit TU - TL	
Code : 8300101	Prix professionnel : **	

** : Voir fichier Excel

Petit colis 24 h chrono /



Type TU - TU.C - TL



Ruban boîte à fumées au mètre / Smoke housing gasket



Code : 43005

Prix professionnel : **



Support boîte à fumées (Support + Intermédiaire) /
Smoke housing support (support + intermediate)
STU2 - TU



Code : 739010

Prix professionnel : **

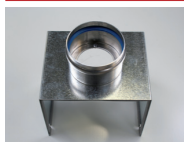

Reprise d'air comburant extérieur / Combustion air
suction kit

TU - TL



Code : 8300101

Prix professionnel : **



Ampoules pour TU (5 pièces) / Bulbs (5 parts)



Code : 8300103

Prix professionnel : **

NOTES

Rayonnement



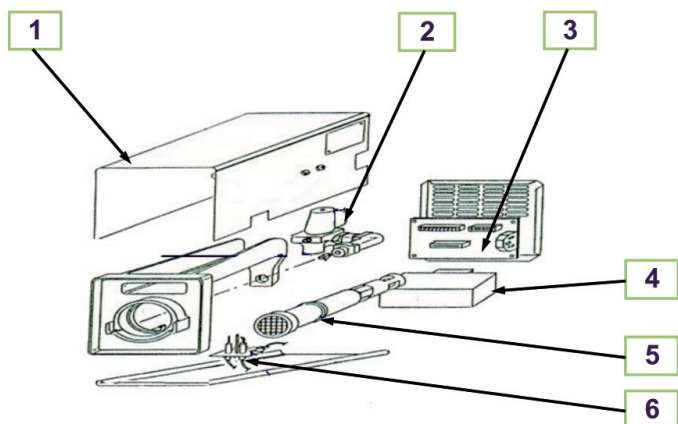







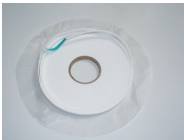





Type STU II - STL

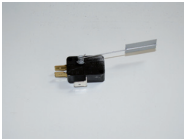

Composants N°	Dénomination	Page
1	Caisson brûleur / Burner box	*
2	Electrovanne gaz / Gas valve	32
3	Circuit imprimé / Printed circuit board	*
4	Boîtier flamme / Gas burner control	32
5	Brûleur / Burner	31
6	Platine électrodes / Spark and detection electrodes	31

* Article fermé (nécessité de remplacer l'appareil)

Type STU II - STL

	Ruban boîte à fumées / Smoke housing gasket Prix au m	
Code : 0043005	Prix professionnel : **	
	Câble haute tension / High voltage cable CSTHT 15000V au mètre	
Code : 0074387	Prix professionnel : **	
	Prise alimentation / Power plug TU	
Code : 0074502	Prix professionnel : **	
	Platine électrodes / Spark + detection electrodes STU 2 - STL	
Code : 7320012	Prix professionnel : **	
	Extracteur fumées STU2 équipé micro-switch / Smoke extractor with micro-switch STL	
Code : 7320016	Prix professionnel : **	
	Brûleur (tube) / Fitted burner STU2/TU équipé	
Code : 7320212	Prix professionnel : **	
	Micro- switch / Micro-switch STUI - STU I Bis - STU2	
Code : 7322502	Prix professionnel : **	
	Support boîte à fumées STU2 (Support + Intermédiaire) / Smoke housing support (support + intermediate)	
Code : 7390010	Prix professionnel : **	

** : Voir fichier Excel

Petit colis 24 h chrono /



Type STU II - STL



Kit Micro-switch / Micro-switch kit
STUI - STUI Bis - STU2



Code : 7390015 **Prix professionnel : ****



Ecran de rayonnement sous tube / Screen



Code : 8130811 **Prix professionnel : ****



Support écran de rayonnement sous tube / Screen
fixation



Code : 8130812 **Prix professionnel : ****



Electrovanne / Gas valve
1/2 FF BRAHMA E.G 12



Code : 9421360 **Prix professionnel : ****



Connecteur 10 bornes carte / 10-pin plug
PC 16C/FL



Code : 9424027 **Prix professionnel : ****



Boîtier contrôle de flamme / Gas burner control
RV 0512 BRT - TU - TUE - STU



Code : 9424134 **Prix professionnel : ****



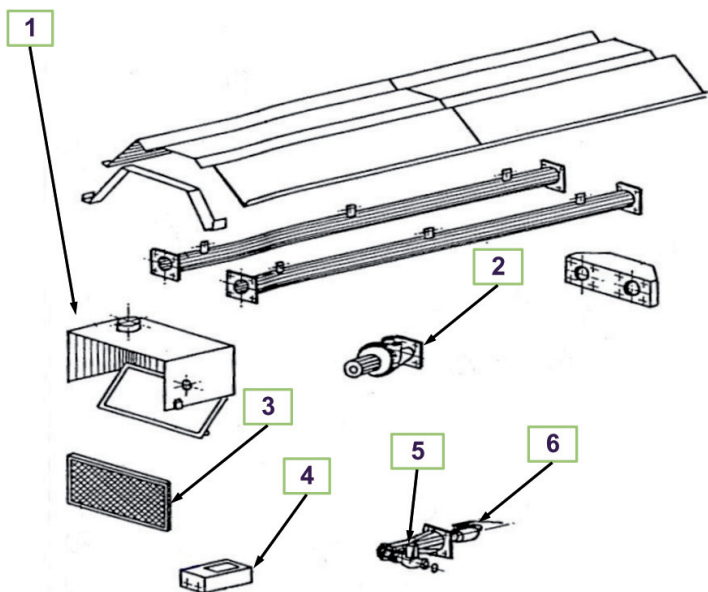









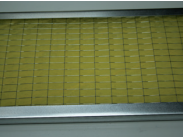

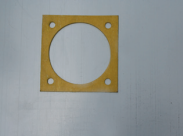

Type STUI















Composants N°	Dénomination	Page
1	Caisson brûleur / Burner box	*
2	Extracteur / Smoke extractor	*
3	Filtre à air / Air filter	34
4	Boitier flamme / Gas burner control	35
5	Electrovanne gaz / Gas valve	35
6	Platine électrodes / Spark and detection electrodes	34

* Article fermé (nécessité de remplacer l'appareil)

Type STUI

	Platine électrodes / Spark + detection electrodes STUI Bis - SRI	
	Code : 7223042 Prix professionnel : **	
	Filtre à air / Air filter (220 X 500 X 25) STUI -STUI Bis	
	Code : 7321303 Prix professionnel : **	
	Joint boîte à fumées / Smoke housing gasket STUI - STUI Bis	
	Code : 7321402 Prix professionnel : **	
	Micro- switch / Micro-switch STUI - STU I Bis - STU2	
	Code : 7322502 Prix professionnel : **	
	Kit Micro-switch / Micro-switch kit STUI - STUI Bis - STU2	
	Code : 7390015 Prix professionnel : **	
	Ecran de rayonnement sous tube / Screen	
	Code : 8130811 Prix professionnel : **	
	Support écran de rayonnement sous tube / Screen fixation	
	Code : 8130812 Prix professionnel : **	
	Electrode d'ionisation / Ionisation electrodes STUI	
	Code : 9412029 Prix professionnel : **	

Type STUI

	Electrode d'allumage / Spark electrodes STUI	
Code : 9412030	Prix professionnel : **	
	Electrovanne / Gaz valve 1/2 FF BRAHMA E.G I2	
Code : 9421360	Prix professionnel : **	
	Connecteur 10 bornes carte / 10-pin plug PC I6C/FL	
Code : 9424027	Prix professionnel : **	
	Boîtier contrôle de flamme / Gas burner control RV 0512 BRT - TU - TUE - STU	
Code : 9424134	Prix professionnel : **	
	Voyant rouge / Red indicator 220V STUI	
Code : 9425010	Prix professionnel : **	
	Voyant vert 220V / Green indicator STUI	
Code : 9425020	Prix professionnel : **	

** : Voir fichier Excel

Petit colis 24 h chrono /



NOTES
