

Type EUROLINE - HARMOLINE - BRT

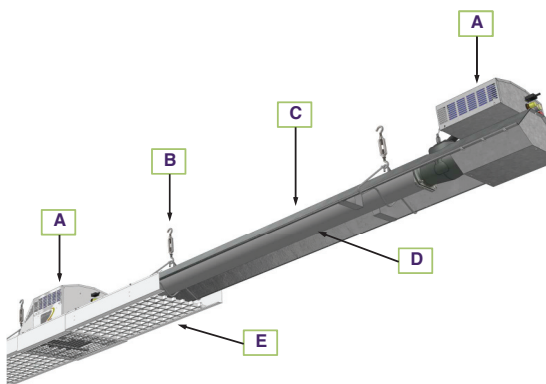

Composants N°	Dénomination	Page
A	Caisson brûleur / Burner box	*
B	Support / Support	*
C	Réflecteur / Reflector	*
D	Tube émetteur / Emitter	*
E	Grille pare balles / Grig (ball-impact guard)	*

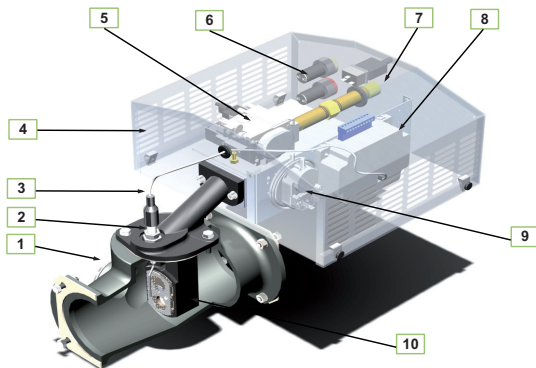

Composants N°	Dénomination	Page
1	Chambre de combustion / Combustion chamber	56
2	Electrode allumage et ionisation / Spark and ionisation electrodes	55
3	Câble allumage et ionisation / Hight voltage cable and ionisation	55
4	Caisson brûleur / Burner box	*
5	Electrovanne gaz / Gas valve	55
6	Voyant lumineux / Indicator	56
7	Ligne gaz / Gas inlet tube	*
8	Boîtier flamme / Gas burner control	55
9	Pressostat / Pressure switch	55
10	Tête de combustion / Burner	56

* Sur consultation uniquement

Type **EUROLINE - HARMOLINE - BRT**



Boîtier contrôle de flamme / Gas burner control
RV 0512 BRT - TU - TUE - STU



Code : 9424134 Prix professionnel : **



Electrovanne gaz / Gas valve
SIT 840 SIGMA 105 mm BRT



Code : 9421005 Prix professionnel : **



Connecteur vanne gaz / Gas valve plug
SIT SIGMA



Code : 9421006 Prix professionnel : **



Electrode allumage et ionisation / Spark and ionisation
electrodes
RMT - RMTS - BRT



Code : 9412385 Prix professionnel : **



Câble haute tension / High voltage cable
BRT



Code : 74296 Prix professionnel : **



Pressostat / Pressure switch
HUBA 5/20 MBAR Préréglé 15 mbar BRT



Code : 9422016 Prix professionnel : **

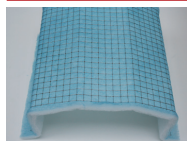

Filtre à air interne / Air filter
BRT



Code : 8430016 Prix professionnel : **

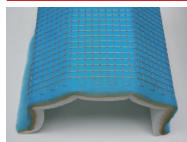

Filtre à air interne BRT spécial ambiances grasses /
Internal air filter for greasy atmosphere
A remplacer chaque année.



Code : 8430017 Prix professionnel : **

** : Voir fichier Excel

Petit colis 24 h chrono /



Type **EUROLINE - HARMOLINE - BRT**



Câblage brûleur / Wiring
BRT



Code : 8450000 Prix professionnel : **



Voyant jaune SV122 sans ampoule / Yellow indicator
without bulb
1.2W 230V



Code : 74532 Prix professionnel : **



Voyant Rouge SV122 sans ampoule / Red indicator with
bulb
1.2W 230V



Code : 74533 Prix professionnel : **



Lampe / Bulb
AS 2.6W 130V BA9S



Code : 8133051 Prix professionnel : **



Socle prise mâle / Plug for socket
BRT



Code : 74498 Prix professionnel : **



Tête de combustion assemblée / Fitted combustion
head



Code : 8120753 Prix professionnel : **



Kit chambre de combustion / Combustion chamber kit
BRT



Code : 8410000N Prix professionnel : **

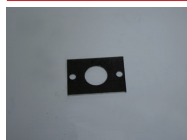









Joint de tête brûleur/coffret / Burner head/housing
gasket

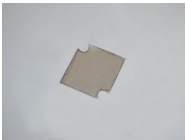

Code : 8130637 Prix professionnel : **

Type **EUROLINE - HARMOLINE - BRT**

	Joint de brûleur /chambre de combustion / Burner head/combustion chamber gasket	
Code : 8130641	Prix professionnel : **	
	Bride de regard flamme/ Flange sight glass	
Code : 8130651	Prix professionnel : **	
	Joint de regard flamme / Sight glass gasket	
Code : 8130652	Prix professionnel : **	
	Mica de regard / Sight glass	
Code : 8130653	Prix professionnel : **	
	Joint à bride / Flange gasket BRT D : 114	
Code : 8420012	Prix professionnel : **	
	Bride / Flange D : 114	
Code : 8420013	Prix professionnel : **	
	Extracteur / Extractor 2 drains TVP-P 400 RDO purges en 3/4	
Code : 8161300	Prix professionnel : **	
	Extracteur VPMR / Extractor 2 drains 450/2 RD0/90/270 2 purges 3/4	
Code : 8161301	Prix professionnel : **	

** : Voir fichier Excel

Petit colis 24 h chrono /



Type **EUROLINE - HARMOLINE - BRT**



Kit extracteur

Kit extracteur / Extractor kit
TVP-P 400 RD0/90/270



Code : 8410100 Prix professionnel : **



Kit extracteur

Kit extracteur / Extractor kit
TVP-P 400 LG 270



Code : 8410101 Prix professionnel : **



Kit extracteur

Kit extracteur / Extractor kit
VPMR 450/2 RD0/90/270



Code : 8410105 Prix professionnel : **



Kit extracteur

Kit extracteur / Extractor kit
VPMR 450/2 LG270



Code : 8410106 Prix professionnel : **



Kit extracteur

Kit extracteur / Extractor kit
VPMR 450/2 RD0/90/270 GROS DEBIT



Code : 8410110 Prix professionnel : **



Silent bloc ventilateur / Silent block for fan



Code : 813082I Prix professionnel : **

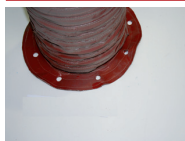

Kit manchette entrée / Suction sleeve kit
TVP-P 400



Code : 8130880 Prix professionnel : **



Kit manchette sortie / Exhaust sleeve kit
TVP-P 400



Code : 8130881 Prix professionnel : **

Type **EUROLINE - HARMOLINE - BRT**

	Tendeur à lanterne / Tightener	
Code : 8130804	Prix professionnel : **	
	Kit manchette entrée / Suction sleeve kit VPMR 450/2	
Code : 8130885	Prix professionnel : **	
	Kit manchette sortie / Exhaust sleeve kit VPMR 450/2	
Code : 8130886	Prix professionnel : **	
	Silencieux de sortie ventilateur en Inox / Fan exhaust silencer stainless steel	
Code : 8130822	Prix professionnel : **	
	Silencieux sortie ventilateur gros débit en Inox / Fan exhaust silencer stainless steel (high flow)	
Code : 8420056	Prix professionnel : **	
	Caisson insonorisant extracteur / Silencer housing for extractor TVP-P-400 extracteur petit débit	
Code : 8161220	Prix professionnel : **	
	Caisson insonorisant extracteur / Silencer housing for extractor VPRM-450/2 extracteur grand débit	
Code : 8161221	Prix professionnel : **	
	Support tube / Tube support D114,3	
Code : 8420008	Prix professionnel : **	

** : Voir fichier Excel

Petit colis 24 h chrono / 

Type **EUROLINE - HARMOLINE - BRT**



Support tube / Tube support
D168 ET 219



Code : 8420009 **Prix professionnel : ****



Chambre de mélange BRT en aluminium / Aluminium
mixing chamber



Code : 8420001 **Prix professionnel : ****

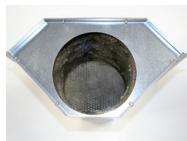

Silencieux d'extrémité tube / Tube end silencer



Code : 8420050 **Prix professionnel : ****



Kit tube d'extrémité / Tube end kit
BRT 20 kW



Code : 8410001N **Prix professionnel : ****



Kit tube d'extrémité / Tube end kit
BRT 24 kW



Code : 8410002N **Prix professionnel : ****



Kit tube d'extrémité / Tube end kit
BRT 30 kW



Code : 8410003N **Prix professionnel : ****



Kit tube d'extrémité / Tube end kit
BRT 40 kW



Code : 8410004N **Prix professionnel : ****

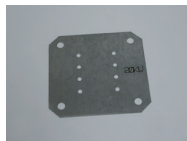

Diaphragme (régleur d'air) carré / Restriction (air flow
adjustment) square
20 kW



Code : 61360 **Prix professionnel : ****

Type **EUROLINE - HARMOLINE -BRT**



Diaphragme (régleur d'air) carré / Restriction (air flow adjustment) square

24 kW



Code : 61361

Prix professionnel : **



Diaphragme (régleur d'air) carré / Restriction (air flow adjustment) square

30 kW



Code : 61362

Prix professionnel : **

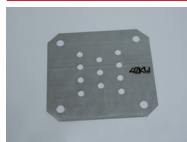

Diaphragme (régleur d'air) carré / Restriction (air flow adjustment) square

40 kW



Code : 61363

Prix professionnel : **

** : Voir fichier Excel

Petit colis 24 h chrono /



Type RMTS

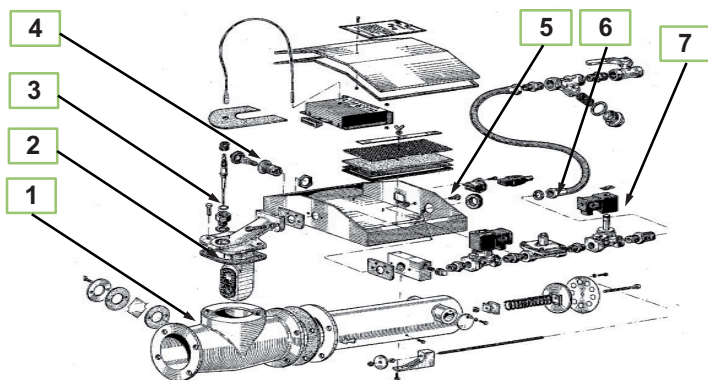

Composants N°	Dénomination	Page
1	Tête de combustion / Combustion head	65
2	Brûleur / Burner	63
3	Electrode allumage & ionisation / Spark & ionisation electrodes	63
4	Voyant lumineux / Indicator	64
5	Caisson brûleur / Burner box	*
6	Ligne gaz / Gas inlet tube	*
7	Electrovanne gaz / Gas valve	63

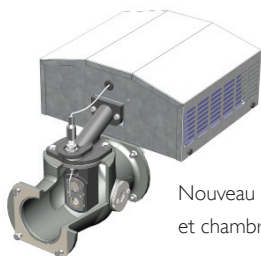

Nouveau brûleur
et chambre de combustion.

* Article fermé (nécessite le remplacement du matériel)

Type RMTS



Kit brûleur / Burner kit
RMTS



Code : PSV94017 Prix professionnel : Nous consulter



Boîtier contrôle de flamme / Gas burner control
without NC relay
RMTS 15 & 24KW sans télégestion PI 6 B/AFL



Code : 9424670 Prix professionnel : **



Kit électrovanne gaz / Gas valve kit
RMT - RMTS



Code : 9421009 Prix professionnel : **



Electrode allumage et ionisation / Spark and ionisation
electrodes
RMT - RMTS - BRT



Code : 9412385 Prix professionnel : **



Câble haute tension / High voltage cable
BRT



Code : 74296 Prix professionnel : **



Tête de combustion assemblée / Fitted combustion
head



Code : 8120753 Prix professionnel : **

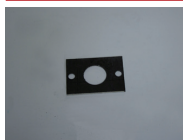

Joint de tête brûleur/coffret / Burner head/housing
gasket



Code : 8130637 Prix professionnel : **



Joint de Brûleur /chambre de combustion / Burner
head/combustion chamber gasket















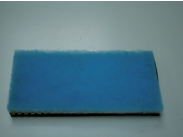



Code : 8130641 Prix professionnel : **

** : Voir fichier Excel



















Petit colis 24 h chrono /



Type RMTS

	Lampe pour voyant / Bulb for indicator RMTS	
Code : 8130716	Prix professionnel : **	
	Filtre à air assemblé / Fitted air filter RMTS	
Code : 8120707	Prix professionnel : **	
	Filtre pour capot / Filter for cover RMTS	
Code : 8130750	Prix professionnel : **	
	Pressostat / Pressure switch DWG-50U 2.5-50 mBar RMT-RMTS	
Code : 8030830	Prix professionnel : **	
	Manchette haute température D159 Lg 300 pour ventilateur / High temperature sleeve for fan	
Code : 8130818	Prix professionnel : **	
	Manchette souple haute température / High temperature sleeve D103 L300	
Code : 8138003	Prix professionnel : **	
	Manchette souple haute température / High temperature sleeve D125 L300	
Code : 8138004	Prix professionnel : **	
	Kit de remplacement automate A87 / A87 PLC replacement kit	
Code : 8130830	Prix professionnel : **	

Type RMTS

	Tendeur à lanterne / Tightener	
	Code : 8130804 Prix professionnel : **	
	Bride acier diamètre 101 / Steel flange diameter 101	
	Code : 8130815 Prix professionnel : **	
	Silent bloc ventilateur / Silent block for fan	
	Code : 8130821 Prix professionnel : **	
	Kit chambre de combustion / Combustion chamber kit RMT - RMTS	
	Code : 842000N Prix professionnel : **	
	Kit vanne d'équilibrage / Balancing valve kit	
	Code : 8410009N Prix professionnel : **	
	Collier / Collar MIKALOR D104-122	
	Code : 9480142 Prix professionnel : **	
	Collier / Collar MIKALOR D122-130	
	Code : 9480143 Prix professionnel : **	
	Collier / Collar MIKALOR D149-161	
	Code : 9480145 Prix professionnel : **	

** : Voir fichier Excel

Petit colis 24 h chrono / 

Type RMT

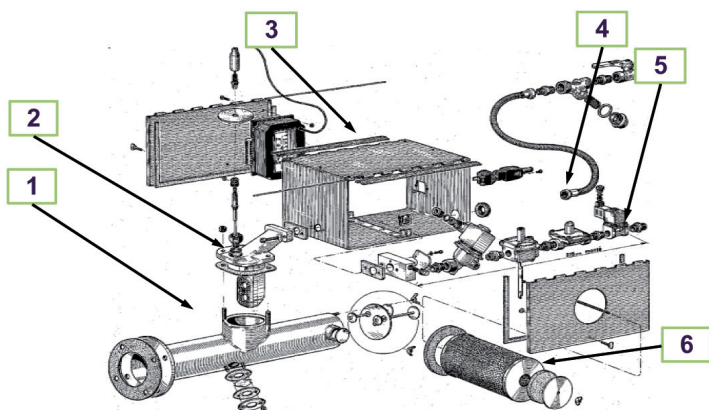

Composants N°	Dénomination	Page
1	Chambre de combustion / Combustion chamber	69
2	Tête de combustion / Combustion head	67
3	Caisson brûleur / Burner box	*
4	Ligne gaz / Gas inlet tube	*
5	Electrovanne gaz / Gas valve	67
6	Filtre / Filter	67

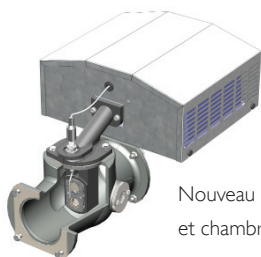

Nouveau brûleur
et chambre de combustion.

* Article fermé (nécessite le remplacement du matériel)

Type RMT

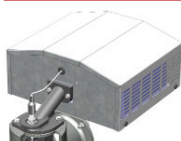

Kit brûleur / Burner kit
RMTS



Code : PSV94017 Prix professionnel : Nous consulter 37€



Boîtier contrôle de flamme / Gas burner control
without NC relay
RMTS 15 & 24KW SANS TELEGESTION PI 6 B/AFL



Code : 9424670 Prix professionnel : **

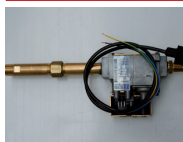

Kit électrovanne gaz / Gas valve kit
RMT - RMTS



Code : 9421009 Prix professionnel : **



Electrode allumage et ionisation / Spark and ionisation
electrodes
RMT - RMTS - BRT



Code : 9412385 Prix professionnel : **



Câble haute tension / High voltage cable
BRT



Code : 74296 Prix professionnel : **



Tête de combustion assemblée / Fitted combustion
head



Code : 8120753 Prix professionnel : **



Filtre à air RMT cylindrique / Cylinder air filter
(140 x 215)



Code : 8130431 Prix professionnel : **



Pressostat / Pressure switch
DWG-50U 2.5-50 mBar RMT-RMTS



















Code : 8030830 Prix professionnel : **

** : Voir fichier Excel

Petit colis 24 h chrono / 21€

Type RMT

	Manchette haute température D159 Lg 300 pour ventilateur / High temperature sleeve for fan	
Code : 8130818	Prix professionnel : **	
	Manchette souple haute température / High temperature sleeve D103 L300	
Code : 8138003	Prix professionnel : **	
	Manchette souple haute température / High temperature sleeve D125 L300	
Code : 8138004	Prix professionnel : **	
	Kit de remplacement automate A87 / A87 PLC replacement kit	
Code : 8130830	Prix professionnel : **	
	Collier / Collar MIKALOR D104-122	
Code : 9480142	Prix professionnel : **	
	Collier / Collar MIKALOR D122-130	
Code : 9480143	Prix professionnel : **	
	Collier / Collar MIKALOR D149-161	
Code : 9480145	Prix professionnel : **	
	Kit vanne d'équilibrage / Balancing valve kit	
Code : 8410009N	Prix professionnel : **	

Type RMT



Kit chambre de combustion / Combustion chamber kit
RMT - RMTS (brides diamètre 114)



Code : 842000N Prix professionnel : **



Tendeur à lanterne / Tightener



Code : 8130804 Prix professionnel : **



Bride acier diamètre D101 / Steel flange diameter D101



Code : 8130815 Prix professionnel : **



Silent bloc ventilateur / Silent block for fan



Code : 8130821 Prix professionnel : **



Joint de Brûleur /chambre de combustion / Burner
head/combustion chamber gasket



Code : 8130641 Prix professionnel : **

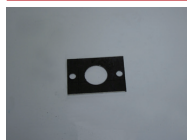

Joint de tête brûleur/coffret / Burner head/housing
gasket



Code : 8130637 Prix professionnel : **

** : Voir fichier Excel

Petit colis 24 h chrono /

