

Type SR11

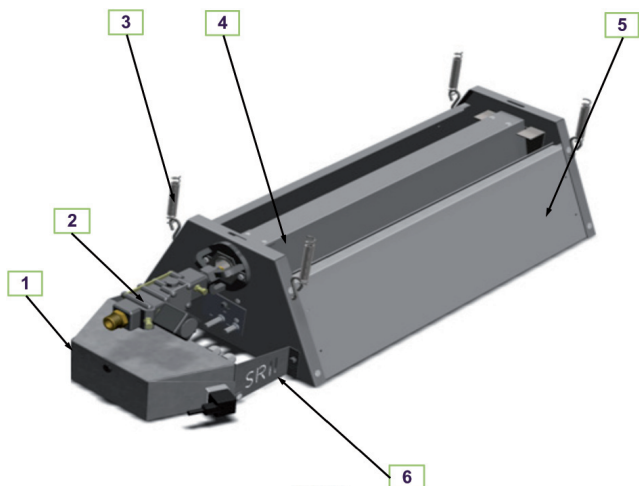

nouveau !

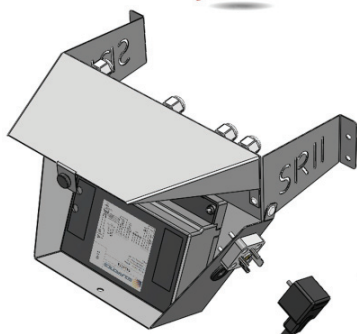

Composants N°	Dénomination	Page
1	Nouveau boîtier flamme / New gas burner control	50
2	Electrovanne gaz / Gas valve	48
3	Ressort de suspension / Spring	*
4	Brûleur / Burner	49
5	Réflecteur / Reflector	*
6	Platine électrodes / Spark & detection electrodes	49

* Sur consultation uniquement

Type SR11

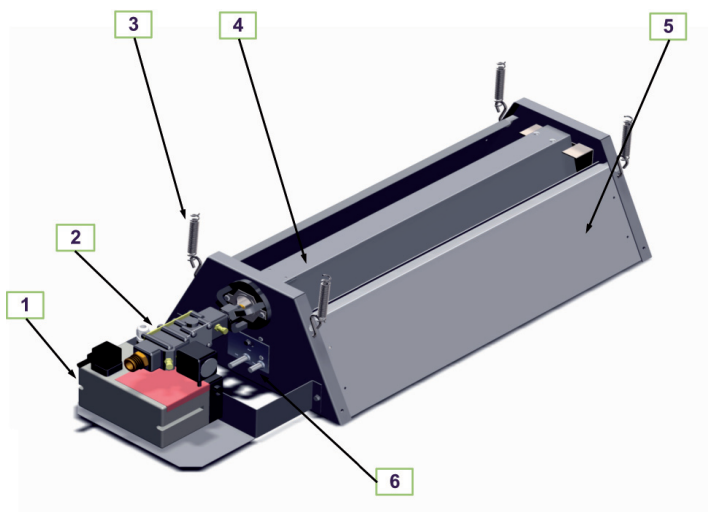

Composants N°	Dénomination	Page
1	Boîtier flamme / Gas burner control	48
2	Electrovanne gaz / Gas valve	48
3	Ressort de suspension / Spring	*
4	Brûleur / Burner	49
5	Réflecteur / Reflector	*
6	Platine électrodes / Spark & detection electrodes	49

* Sur consultation uniquement

Type SR11



Boîtier contrôle de flamme RV 1 allure / Gas burner control 1 stage
SR 21-31-41



Code : 9424131 Prix professionnel : **



Boîtier contrôle de flamme RV 1 allure / Gas burner control 1 stage
SR 61-81



Code : 9424132 Prix professionnel : **



Boîtier contrôle de flamme RV 2 allures / Gas burner control 2 stages
SR 42-62-82



Code : 9424141 Prix professionnel : **

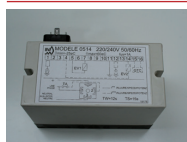

Boîtier contrôle de flamme RV 1 allure / Gas burner control 1 stage + NC relay
GTC



Code : 9424135 Prix professionnel : **



Boîtier contrôle de flamme RV 2 allures / Gas burner control 2 stages + NC relay
GTC



Code : 9424136 Prix professionnel : **



Electrovanne gaz / Gas valve
TK 15 SP 14 - 1 Allure



Code : 9421371 Prix professionnel : **

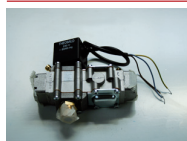

Electrovanne gaz / Gas valve
TK 15 SP88 pour flexible - 1 Allure 2 brûleurs



Code : 9421376 Prix professionnel : **













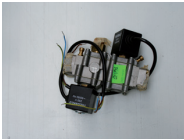

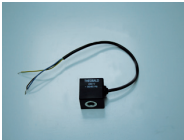



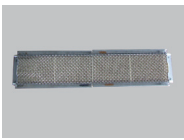



Electrovanne gaz / Gas valve
TK 25 SP89 pour flexible - 2 Allures



Code : 9421375 Prix professionnel : **

Type SR11

	Electrovanne gaz / Gas valve TK 15 SP 21C THEOBALD Coude Cuivre 1 Allure 2 bruleurs	
Code : 9421355	Prix professionnel : **	
	Electrovanne gaz / Gas valve TK 25 SP 22C Coude Cuivre 2 Allures	
Code : 9421369	Prix professionnel : **	
	Bobine électrovanne / Solenoid coil TK 220V	
Code : 9421364	Prix professionnel : **	
	Platine électrode / Spark + detection electrodes SR11	
Code : 7223049	Prix professionnel : **	
	Kit brûleur 4 plaques SAV France / 4 tiles burner kit	
Code : 7220300	Prix professionnel : **	
	Kit brûleur 6 plaques SAV France / 6 tiles burner kit	
Code : 7220302	Prix professionnel : **	
	Kit brûleur 8 plaques SAV France / 8 tiles burner kit	
Code : 7220304	Prix professionnel : **	
	Kit brûleur 4 plaques lieu de Culte / 4 tiles burner kit, place of worship	
Lieu de Culte	Code : 7220306	Prix professionnel : **
		

** : Voir fichier Excel

Petit colis 24 h chrono /



Type SR11



Kit brûleur 6 plaques lieu de Culte / 6 tiles burner kit, place of worship



Lieu de Culte

Code : 7220307 Prix professionnel : **



Kit brûleur 8 plaques lieu de Culte / 8 tiles burner kit, place of worship



Lieu de Culte

Code : 7220308 Prix professionnel : **



Câble avec prise d'alimentation / Cable with plug LG IM



Code : 9462046 Prix professionnel : **



Flexible gaz / Gas flexible + 2 Viton gaskets 1/2" + 2 joints VITON LG 122mm SR11



Code : 7220100 Prix professionnel : **



Nouveau kit de remplacement boîtier de contrôle 1 allure 1 brûleur



Code : 7220371 Prix professionnel : **



Nouveau kit de remplacement boîtier de contrôle 2 Allures 2 brûleurs



Code : 7220373 Prix professionnel : **



Nouveau kit de remplacement boîtier de contrôle 1 Allure 2 brûleurs



Code : 7220374 Prix professionnel : **

Type SRI - SRI bis

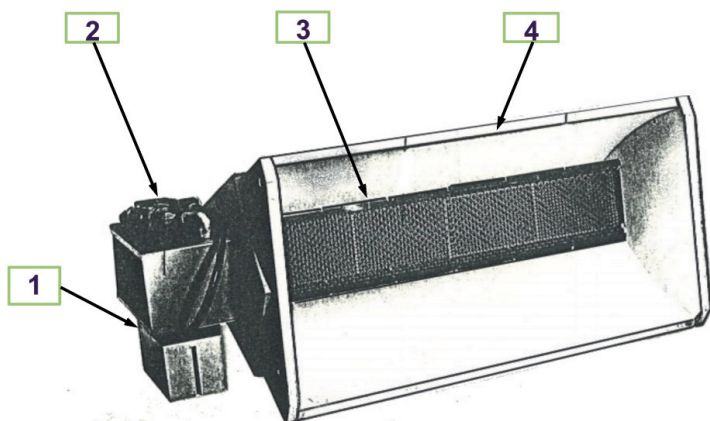

Composants N°	Dénomination	Page
1	Boîtier flamme / Gas burner control	52
2	Electrovanne gaz / Gas valve	*
3	Brûleur / Burner	*
4	Réflecteur / Reflector	*

* Article fermé (nécessite le remplacement du matériel)

Type SRI - SRI bis



Boîtier contrôle de flamme RV 1 allure / Gas burner control 1 stage
SR 21-31-41



Code : 9424131 Prix professionnel : **



Boîtier contrôle de flamme RV 1 allure / Gas burner control 1 stage
SR 61-81



Code : 9424132 Prix professionnel : **



Boîtier contrôle de flamme RV 2 allures / Gas burner control 2 stages
SR 42-62-82



Code : 9424141 Prix professionnel : **

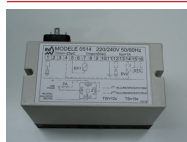

Boîtier contrôle de flamme RV 1 allure / Gas burner control 1 stage + NC relay
GTC



Code : 9424135 Prix professionnel : **



Boîtier contrôle de flamme RV 2 allures / Gas burner control 2 stages + NC relay
GTC



Code : 9424136 Prix professionnel : **



Bobine électrovanne / Solenoid coil
SRI - SRI Bis



Code : 9421340 Prix professionnel : **



Platine électrodes / Spark + detection electrodes
STUI Bis - SRI



Code : 7223042 Prix professionnel : **



Flexible électrovanne gaz, et 2 joints VITON / Gas flexible + 2 Viton gaskets
LG 175mm 3/8 SRI - SRI Bis



Code : 7221420 Prix professionnel : **

Type SRI - SRI bis



Filtre / Filter

SR 21-31-41 | 20X202 SRI



Code : 7209518

Prix professionnel : **

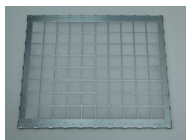

Filtre / Filter

SR 42-62-82 SRI



Code : 7209519

Prix professionnel : **

** : Voir fichier Excel

Petit colis 24 h chrono /

